

LOAD CURRENT DEPENDENT FUZZY LOGIC BASED CONTROLLER FOR BUCK DC/DC CONVERTER

****Jawad Radhi * , Dr. Ramzi S. Ali* , & Dr. Ali Fathel
**Dept. Of Electrical Engineering , Basrah University
*Dept. Of Computer Science , Basrah University**

Abstract

This paper presents and discusses a buck DC/DC converter control based on fuzzy logic approach, in which the fuzzy controller has been driven by voltage error signal and a current error signal for which the load current has been taken as a reference one.

The validity of the proposed approach has been examined through starting the buck DC/DC converter at different loading and input voltages (to monitor the starting performances), exposing the converter into large load resistance and input voltage step variations (to explore its dynamic performance), in addition to step and smooth variation in the reference voltage (to see its ability in readjusting its operating point to comply with the new setting).

The simulation results presented an excellent load & line regulations abilities in addition to a good reference tracking ability. It also showed the possibility of using the buck converter as smooth variable voltage source (under smooth reference voltage variations).

مسيطر مضطرب لتيار مستمر من النوع الخافض يعتمد تيار الحمل

جواد راضي ، * دا رمزي سالم ، ** دا علي فاضل
جامعة البصرة / قسم الهندسة الكهربائية
جامعة البصرة / قسم علوم الحاسبات

الخلاصة:

هذا البحث يقدم ويناقش سيطرة مضطرب لتيار مستمر من النوع الخافض تعتمد إشارات خطأ الفولتية و خطأ تيار الحمل الذي يعتمد تيار الحمل مرجع له .

تم تقييم صلاحية التقنية المقترحة من خلال تشغيل المحول الفعلي تحت أحمال وفولتيات إدخال مختلفة (مراقبة أداء بدأ التشغيل) وكذلك تعريضه أثناء استمراره بالعمل إلى تغيرات كبيرة في فولتيات الإدخال و قيم مقاومة الأحمال هذا إضافة إلى تعريضه إلى تغير ناظم و احمال مفاجئ في فولتية المرجع لمعرفة قابليته في التكيف مع نقطة العمل الجديدة .

أظهرت نتائج المحاكاة تنظيم متميز ضد تغيرات فولتية المصدر و قيم مقاومة الحمل وكذلك عن قابلية جيدة في مجازة فولتية خط المرجع إضافة إلى عرض إمكانية اعتماد هذا المحول كمصدر فولتية مستمر ذو خطوات تغير ناعمة استجابة لتغير ناظم في فولتية خط المرجع

1-Introduction

The selection of the control techniques for DC/DC converters form an essential research topics in power electronic field

DC/DC converters are nonlinear[1].They are characterized by time varying operating topologies , a situation which restrict the validity of traditional solutions

Traditional control solutions (PID type) depend linearized mathematical model derived for small perturbation around certain operating point . The accuracy and performance of these controllers depend upon the operating point . So the presence of parasitic elements , time varying loads, and variable supply voltage harden the determination of the control variable.

To overcome the foregoing limitations of traditional controllers , fuzzy logic based approach arises as a promising alternative

Fuzzy logic based approach does not require an accurate mathematical model[2]. It is based on expert knowledge that convert human concept into an automatic control strategy [3] . Its performance accuracy is function of the proper selection of its input variables.

Literature [4,5,6] utilize output voltage error ($V_O - V_{ref}$) and rate of error change ($e_k - e_{k-1}$) as an inputs.

Unfortunately these earlier approaches show poor dynamic performances and stability.

Literature [7] uses output voltage error ($V_O - V_{ref}$) and inductor current error ($i_L - i_{Lref}$) as an inputs . Here , the inductor current reference had been extracted from the inductor current by mean of low pass filter.

In this paper , output voltage error ($V_{ref} - V_O$) and an inductor current error ($i_R - i_L$) signals had also been used but the load (i_R) current had been used as current reference (depending on the fact that under steady state , the average load current equal that of the inductor current because the capacitor average current equals zero).

2-Buck converter non linearity

Buck DC/DC converter is member of the DC/DC converters family .It is intended to convert a dc input voltage into a dc output one with a magnitude less than the input voltage .This means it functions as step down transformer but in the dc domain.

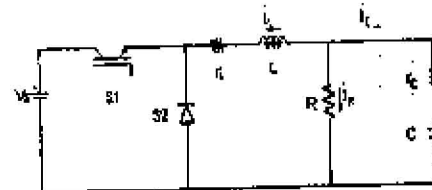
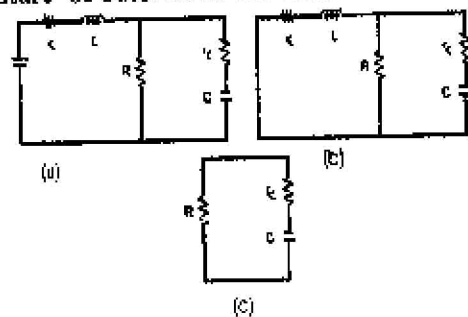

Fig.(1): Buck converter power circuit elements

Fig(1) shows the main components of this converter . These components can be sorted into linear components and nonlinear components . The linear components are addressed by the inductor , capacitor , and load resistance . The nonlinear ones are represented by the transistor and the diode switches.

The switching modes of these nonlinear elements under the control of pulse width modulation , setup three distinct linear circuit topologies (fig (2)). The cyclic operation of these topologies leads to nonlinear dynamics . This inherent non linearity stands for the restriction of the PID accuracy and validity of the standard solutions based on small signal linearized models. It also stands for the recommendation of adopting a nonlinear solutions copying with the non linear nature of buck dc/dc converter.



Fig(2): Possible buck converter cyclic topologies
a: first topology b:second topology c:third topology

3-Buck converter distinct topologies

A close look to the buck converter circuit (see fig(1)), indicates that the transistor and the diode can not be on at the same time since this leads to short circuiting of the input supply. There fore the switching elements of the buck DC/DC converter are restricted into one of three modes .These are:-

Mode 1: The transistor is on and the diode is off.

Mode 2: The transistor is off and the diode is on.

Mode 3: The transistor is off and the diode is off.

Each of these operating modes give raise to a unique circuit topology .Each of these topologies can be expressed by a set of linear differential equations as derived bellow:

Mode 1

$$V_s = i_L(t).r_L + V_L(t) + V_o$$

$$V_L(t) = L di_L(t)/dt$$

$$di_L(t)/dt = (V_s - V_o)/L - r_L i_L(t)/L \text{ -----(1)}$$

$$i_L(t) = i_C + i_R$$

$$i_L(t) = C dV_C(t)/dt + V_o/R$$

$$i_L(t) = C d(V_o - i_C r_C)/dt + V_o/R$$

$$i_L(t) = C dV_o/dt - C r_C di_L(t)/dt + (C r_C/R). dV_o/dt + V_o/R$$

$$C(1+r_C/R)dV_o/dt = i_L(t) + C r_C di_L(t)/dt - V_o/R \text{ -----(2)}$$

Substitute (1) in (2)

$$dV_o/dt = [(1/C - r_C r_L/L)i_L(t) - (r_C/L + 1/RC)V_o + r_C V_s/L] / (1+r_C/R) \text{ -----(3)}$$

Mode 2

$$0 = i_L(t).r_L + V_L(t) + V_o$$

$$0 = i_L(t).r_L + L di_L(t)/dt + V_o$$

$$di_L(t)/dt = -V_o/L - r_L i_L(t)/L \text{ -----(4)}$$

$$dV_o/dt = [(1/C - r_C r_L/L)i_L(t) - (r_C/L + 1/RC)V_o] / (1+r_C/R) \text{ -----(5)}$$

Mode 3

$$i_L = 0$$

$$0 = V_o/R + C dV_o/dt$$

$$0 = V_o/R + C d(V_o + V_o.r_C/R)/dt$$

$$0 = V_o/R + C(1 + r_C/R)dV_o/dt$$

$$dV_o/dt = -V_o/[C(1 + r_C/R)] \text{ -----(6)}$$

4-Design of the proposed system

The complete system of the fuzzy controlled buck converter (fig.(3)) consists of two parts. These are the power circuit and the control (or drive circuit). The former acts as an interface between the input voltage supply and the load . The later controls the energy flow in the interface in such a way that keep the load voltage as desired irrespective of input supply voltage or load resistance variations.

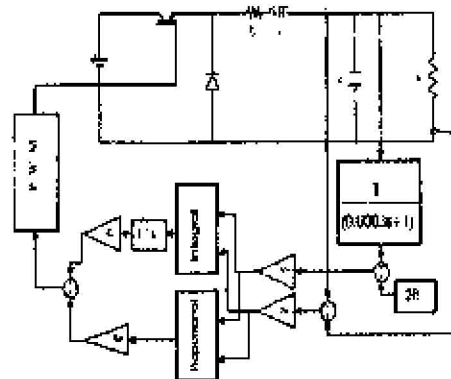

Fig.(3) : Complete system of the fuzzy controlled buck converter

The power circuit consists of a transistor switch (S1) ,diode switch (S2), an inductor (L) with series resistance (r_L), capacitor (C) , and the load resistance (R) .

The circuit is assumed to operate in continuous current conduction mode. Under such assumption , the power circuit will loop repeatedly through two topologies

In the first topology (fig.(2a)), the inductor current ramps up proportionally to the difference of the input supply voltage and the output voltage, inversely to the inductance value , and inversely to the switching frequency (f_s) as it is obvious from : $\Delta i_L = (V_s - V_o).D1/(L.f_s)$ (where Δi_L refers to the inductor current increment during the period $D1/f_s$, $D1$ is the duty ratio of the transistor switch , and f_s is the switching frequency).

In the second topology (fig.(2b)) , the inductor current ramp down proportionally to the output voltage , inversely to the

inductance value , and inversely to the switching frequency (fs) as can be detected from : $\Delta i_L = -V_o.D2/(L.fs)$ (where Δi_L refers to the inductor current decrement during the period $D2/fs$, $D2$ is the duty ratio of the diode switch).

So for a given input / output specifications & pre specified switching frequency , the value of the inductance plays an important role in controlling the maximum current deviation & keeping the converter far from discontinuous current conduction mode This means that the inductor is one of the circuit elements that must be selected carefully to fulfill the requirements of circuit operating mode and performance.

Under low output voltage ripple assumption, the capacitor current can be approximated by inductor current minus the average load current , in fact it is the ac component of the inductor current and it is triangular in waveform with peak to peak value equals that of the inductor current ripple. $1/C$ times its integral , over its positive half cycle define the voltage variation across the capacitor .If the capacitor equivalent series resistance (ESR) has been assumed to be very small , the output voltage will be equal to that of the capacitor . So the capacitor forms an effective factor in determining the output voltage ripple and hence it must be properly selected.

Inductance calculation criteria

Referring to eq.(1) the inductor voltage is slightly less than (V_s-V_o) . Assuming small resistance for the inductor wire , the inductor voltage can be approximated by:-

$$V_s-V_o = L\Delta i_L/D1.T \text{ -----(7)}$$

For continuous current conduction

$$D1 = V_o/V_s \text{ so :}$$

$$(1-D1)V_s = L.\Delta i_L/D1.T$$

$$((1-D1)V_s - L.\Delta i_L)/(V_o.T/V_s)$$

$$(1-D1) = L\Delta i_L/(V_o.T)$$

At the boundary of continuous and discontinuous mode , $\Delta i_L=2$ average load current. This means

$$\Delta i_L=2.P_{OUT}/V_o$$

$$\text{So, } (1-D1)=L_{CRITICAL}.2.P_{OUT}/(V_o^2.T) \\ L_{CRITICAL}=(1-D1).T.V_o/(2.I_{LOAD}) \text{ -----(8)}$$

From the foregoing analysis, one can say that the inductance can be determined in term of the required current deviation or the minimum load current .

In term of the current deviation the inductance L will be :-

$$L >= (V_s-V_o).D1_{MAX}.T/\Delta i_L \text{ -----(9)}$$

In term of the minimum load current it will be:-

$$L >> (1-D1_{MAX}).T.V_o/(2.I_{LOADMIN}) \text{ -----(10)}$$

Where $D1_{MAX}$ represents the duty ratio at the highest input voltage .

Capacitor calculation Criteria

To get low output voltage ripple , the capacitor should absorb the inductor current ripple . That means it should absorb current of triangular form with peak to peak value of Δi_L . This gives a voltage variation across the capacitor equals to $1/C$ times the triangular area $[0.5(T/2).(\Delta i_L/2)]$. Therefore to get an output voltage ripple of ΔV volts, the following formula should be used:

$$C >= \Delta i_L.T/(8\Delta V) \text{ -----(11)}$$

$$\text{Where } \Delta i_L=(V_s-V_o).D1.T/L$$

System Requirements

Input voltage =	50 ± 30%	(V)
Output voltage =	28	(V)
Load Power :	25 to 125	(W)
Max.output voltage ripple<=	0.5% output voltage	(V)

Selected Components

L =	300μH
C =	100μH
r _L =	0.005Ω (assumed)
r _C =	0 Ω (assumed)

4.2 Fuzzy controller design

Selection of input & control variables

The control goal is to keep the output voltage as close as possible to the reference

voltage despite changes in the input dc supply and despite variation of the load resistance. This goal can be successfully done , if the controller :-

- 1-Sense the more expressive state variables
- 2-Generate the right control variable.
- 3-Aware of how to drive the buck converter.

The foregoing circuit analysis, states that for buck converter , the output voltage can be changed if the supply voltage and/or the duty ratio have been changed . It also states that the inductor current carries an information about the supply voltage behavior .So the error of these state variables can be used as an expressive input variables & the duty ratio can be depended as the right output(control) variable for the fuzzy controller.

Membership functions selection of Fuzzy input variables

The behavior of the state variables after the occurrence of disturbances depend upon the sizes of the disturbance and progress of time. They may be far from the set point, may be close to the set point , & may be at the vicinity of the set point

Relative to the position of the set point, they are either to the left or the right of the set point.

This fuzzy picture of the state variables simply suggests five labels to the voltage error and current error.

In this paper, five labels have been used and distributed linearly over the normalized universe of discourse that extent from -1 to +1. These labels are Shown in Fig.(4a&b).

Membership functions selection of fuzzy output variable

The output fuzzy variable labels reflect the expert perspective of the amount of correction required.

To get compromise solution between computation complexity and control smoothness, seven labels have been selected (fig.(4c)).

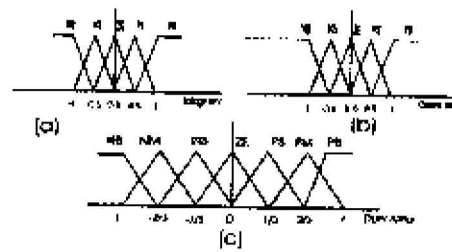

Fig(4): Fuzzy controller membership functions
a: Voltage error b: Current error c: Duty ratio

The fuzzy controller mimic the expert in the control loop. Implicitly , it has a data base of rules that summarize the control expert towards actions taken by the changes in the used state variables . Linguistically, each of these rules take the form of the following if statement :

If X is X1 & Y is Y1 THEN Z is Z1

For two input variables & one output variable , these control rules are tabulated in table form.

Table 1 & 2 summarize the rule sets for the proportional and the integral fuzzy controller used in this proposed controller. The selection of the rules weights has been done through the selection of the centers of the output fuzzy variable labels

		Error				
		NB	NS	ZE	PS	PB
Change of error	PB	-1	1/3	2/3	1	1
	PS	-1	0	1/3	2/3	1
	ZE	-1	-1/3	0	1/3	1
	NS	-1	-2/3	-1/3	0	1
	NB	-1	-1	-2/3	-1/3	1

Table 1: (Rules set for the proportional controller.)

		Error				
		NB	NS	ZE	PS	PB
Change of error	PB	0	1/3	2/3	1/3	0.2
	PS	0	0	1/3	2/3	0.1
	ZE	0	-1/3	0	1/3	0
	NS	-0.1	-2/3	-1/3	0	0
	NB	-0.2	-1/3	-2/3	-1/3	0

Table 2: (Rules set for the integral controller.)

Selection of error normalization factors

The normalization factor sets up the controllable range, the range beyond which the error is considered as saturated. Out side this range, the error is interpreted as extremely positive big or extremely negative big.

Proper selection of these factors ensure stable system operation with improved overall performance both at the starting and steady state conditions .

Here , the voltage error and the current error normalization factors have been selected through testing the system performance under different setting of these factors . The ones selected were those whose static & dynamic performances were satisfactory from the point of view of stability , settling time , peak value , and valley value at the time of disturbance occurrence . The settings used were :
Voltage error normalization factor $N_v=0.2$
Current error normalization factor $N_i=1.0$

Selection of the gain factors of the proportional & integral fuzzy controllers

The fuzzy controller used here, consists of two sub controllers. These are proportional fuzzy logic based controller & the integral fuzzy logic based controller. The function of the proportional controller is to make instantaneous duty ratio correction action complying with the magnitude and direction of the errors. The function of the integral controller is to minimize the steady state error by producing an incremental or decremental duty ratio correction action .

The system has been tested under different gain setting of these sub controllers .The ones that gave satisfactory starting , steady state , and dynamic performances were : $K_p=0.7$; $k_i=10000$.

Fuzzy controllers modeling

The fuzzy controller inference rules are usually given in term of rules table. If single tone fuzzy membership functions

are used for the labels of the output fuzzy variable, the rules table can be replaced by a two dimensional matrix and the over all fuzzy processing can be contained in one programming structure as stated below:

Replacing the rules table by two dimensional matrix (say Z), referring to its row count by "R" & its column count by "C", and letting $A(i)$ be the i 'th label of the current error object and $V(j)$ be the j 'th voltage error object label , the crisp output of the fuzzy controller can be given by:

$$D = \frac{\sum_{i=1}^R \sum_{j=1}^C Z(i,j) \cdot \text{Min}[A(i), \text{membership}(e), v(j), \text{membership}(ve)]}{\sum_{i=1}^R \sum_{j=1}^C \text{Min}[A(i), \text{membership}(e), v(j), \text{membership}(ve)]}$$

The Mat lab./ SIMULINK representation of this equation for the proportional (or the integral) fuzzy controllers (depended in this paper) are shown in fig(5).

5-Simulation results & discussion

The proposed approach has been tested in the MATLAB/Simulink environment for:-
1-Sudden step changes in the supply voltage.
2-Sudden step changes in the load resistance .
3-Starting the converter under different loading and input voltages.
4-Sudden changes in the reference voltage.
5-Smooth changes in the reference voltage.

The simulation results of these tests have been plotted in fig.(6) to fig.(16). They give the following readings:-

Fig(6) displays the response under sudden changes in the supply voltage .The supply changes were $\pm 30\%$ of the nominal value (50V). The settling time was very short .The maximum over shoot was less than 0.5V (less than 2%). The minimum valley was less than 0.5V. The maximum current overshoot & the minimum valley were slightly greater than 0.5A.

Fig(7) shows the effect of load resistance toggling under the minimum expected

input voltage (35V). The maximum overshoot was about 1.3V(4.6%) & it occurred when the load changed suddenly from full load ($R=6.272\Omega$ or $P=125W$) to light load (31.36Ω or $P=25W$). The minimum valley was about 2V(7.14%) and occurred at the same conditions. Step changes reduction reduced the overshoots & valleys. Current overshoots & valleys follows the same rule as that of the voltage and the maximum current overshoot was about 2A

Fig(8) & fig(9) do the same job as fig(7) do, but they add an extra information which states that the performance is improved as the supply voltage is increased

Fig(10), fig(11), & fig(12) state that in the specified input voltage range the converter started successfully with light load as well as rated load.

Fig(13), fig(14), & fig(15) display the converter responses under small and large step changes in the reference voltage. 6V (21.4%) & 18V (64.28%) step changes had been adopted. For rated load and for the used input voltages the settling times were very shorts, but the maximum overshoot that occurred at the transition from low reference to high one was increasing as the input voltage was increased. The time required to jump from high reference into low one increases as the load resistance increased.

Fig(16) pinpoints the behavior of the buck converter when subjected to smooth reference voltage variation (up to 50 Hz). The converter succeeded in keeping track with such reference variation showing a variable voltage source feature.

6-Conclusion

A complete fuzzy based controller for buck DC/DC has been presented. The fuzzy controller has been fed with output voltage error and an inductor current error. The load current has been adopted as virtual reference to extract the inductor current error.

The simulation results showed that, for the permissible input voltage range and the desired power range, the buck converter

under the control of the proposed fuzzy controller has an excellent line regulation, load regulation, starting performance, & reference tracking capability.

References

- [1]: CHI K. TSE & MARIO DI "Complex Behavior in Switching Power Converters", Proceeding of the IEEE, Vol. 90, NO.5, MAY 2002, pp. 768-781.
- [2]: Cornelius T, "Fuzzy Logic And Expert Systems application", Academic Press 1998.
- [3]: Fang Hsien & C.Q. Lee, "Comparison of Fuzzy Logic and Current-Mode Control Techniques in Buck, Boost, and Buck/Boost Converters", Proc. Of the IEEE, PESC, Vol.2, pp.1079-1085.
- [4]: Wing-Chi So & Y. Lee, "Development of a Fuzzy Logic Controller for DC/DC Converters : Design, Computer Simulation, and Experimental Evaluation", IEEE, Transactions on Power Electronics, Vol. 11, NO.1, January 1996, pp. 24-31.
- [5]: Sung-hoe Huh and Gwi-Tae Park, "An Adaptive Fuzzy Controller for Power Converters", IEEE International Fuzzy Systems Conference Proceeding, August 22-25, 1999, Seoul, Korea, pp.434-439.
- [6]: Fumio Ueno and et. al, "Regulation of Cuk Converters using Fuzzy Controllers", In INTELEC '91, Record, Nov. 1991, pp. 261-267.
- [7]: P. Mattavelli, L. and et. al, "General Purpose Fuzzy Controller for DC/DC converters", IEEE Trans. On Power Electron., vol 12, Jan 1997, pp 79-86

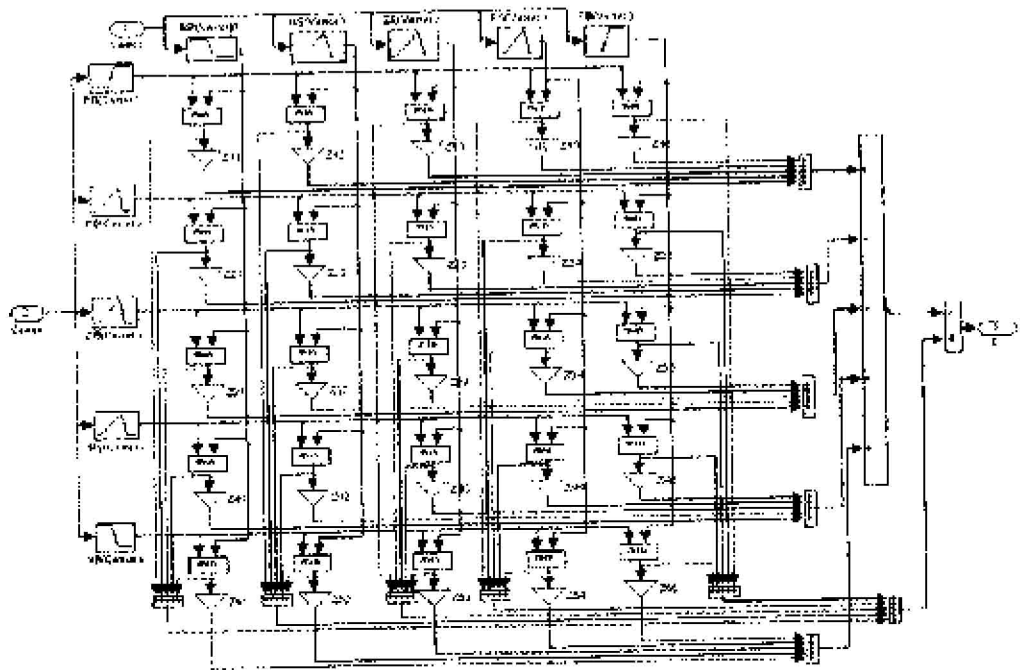

Fig(5): Matlab/Simulink modeling of the proposed fuzzy controller

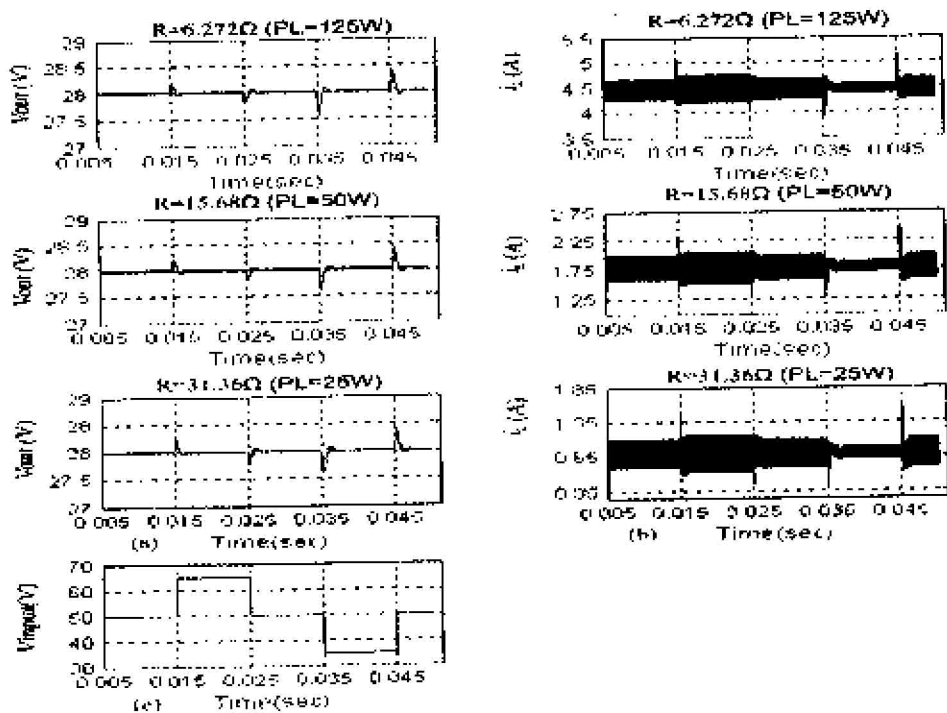

Fig(6): Simulation results under step changes in the input voltage
a: Voltage response b: Current response c: input voltage

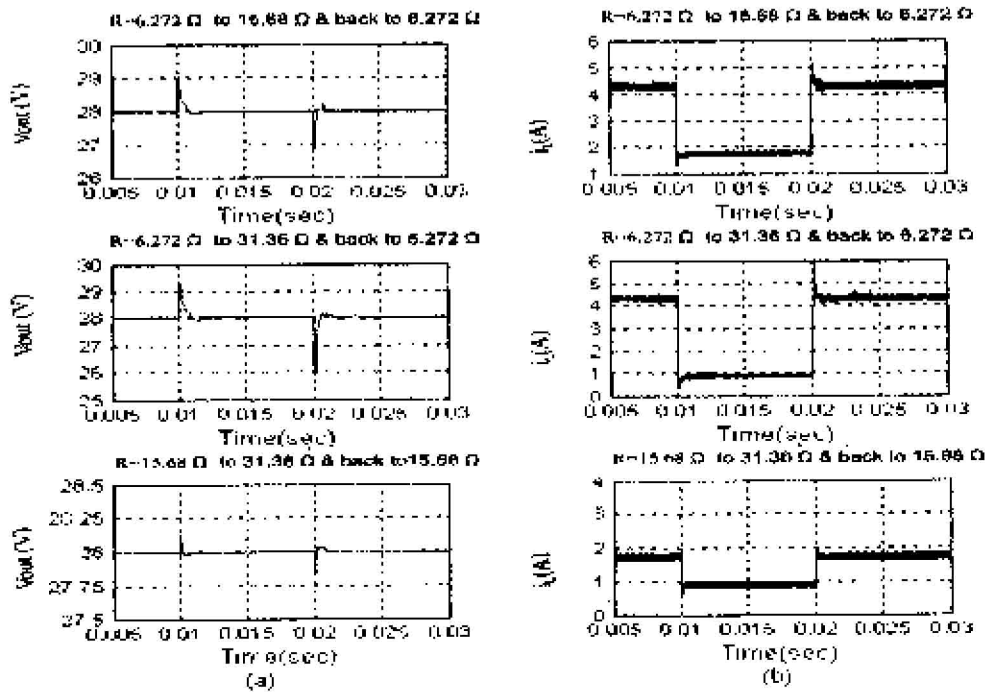
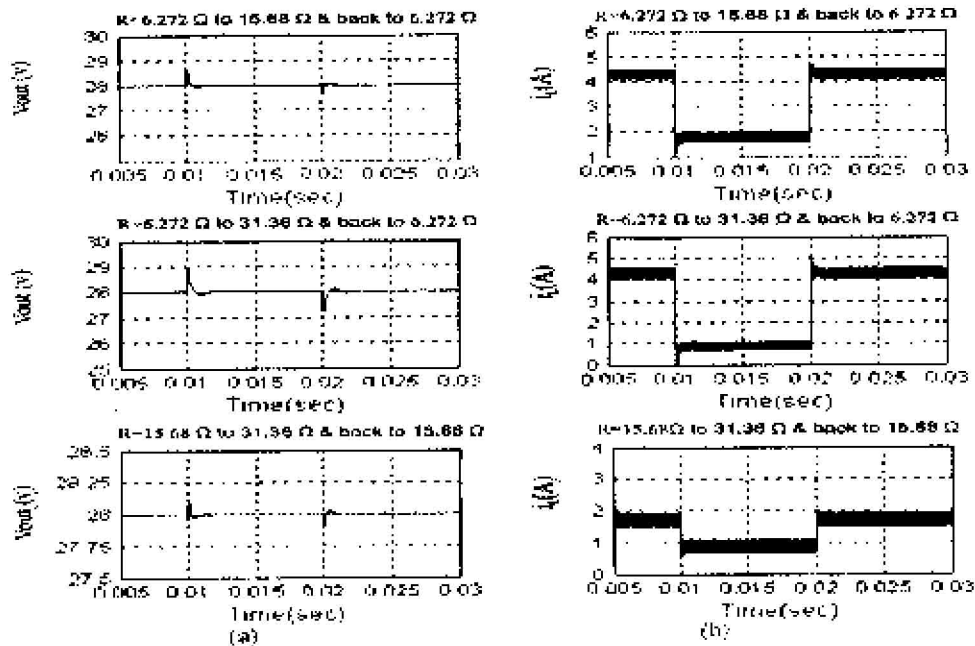

Fig.(7):Simulation results under load resistance step changes and an input voltage of 35V

a:Voltage response b:Current response



Fig(8). Simulation results under load resistance step changes and an input voltage of 50V

a:Voltage response b:Current response

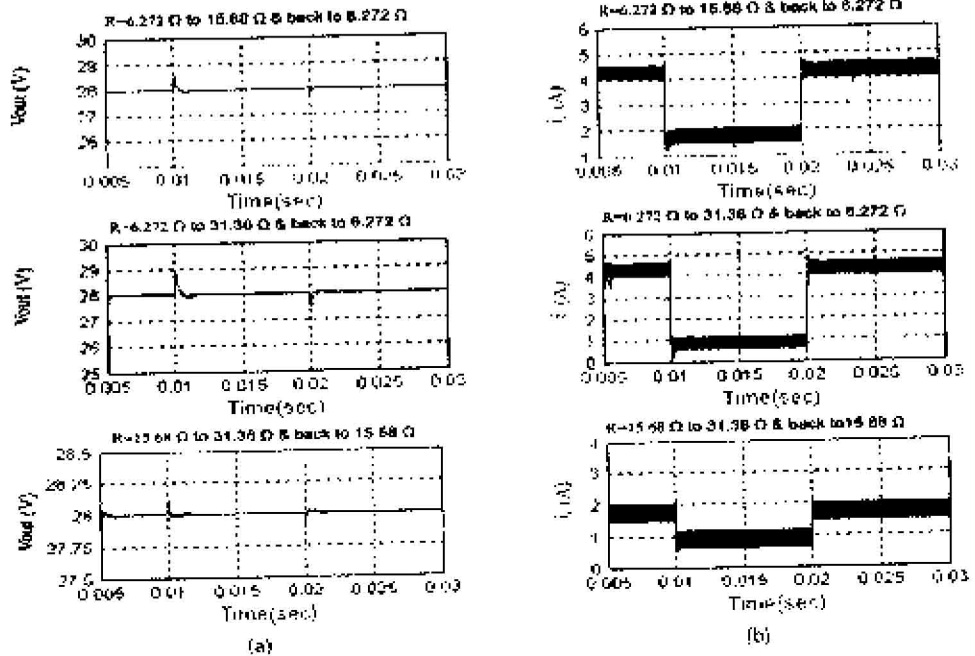

Fig(9): Simulation results under load resistance step changes and an input voltage of 65V

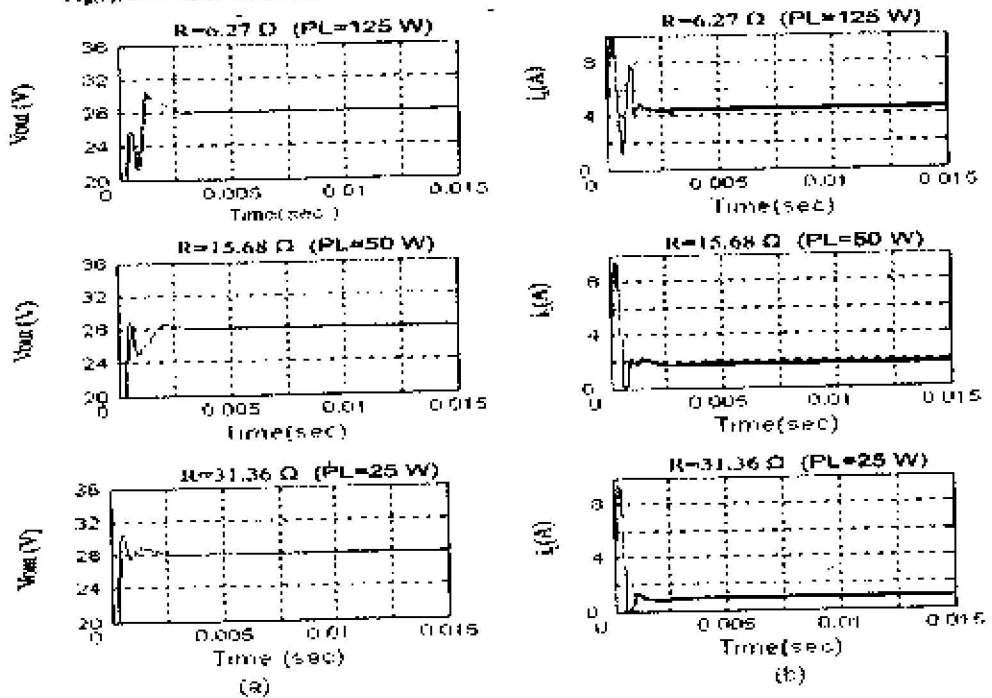
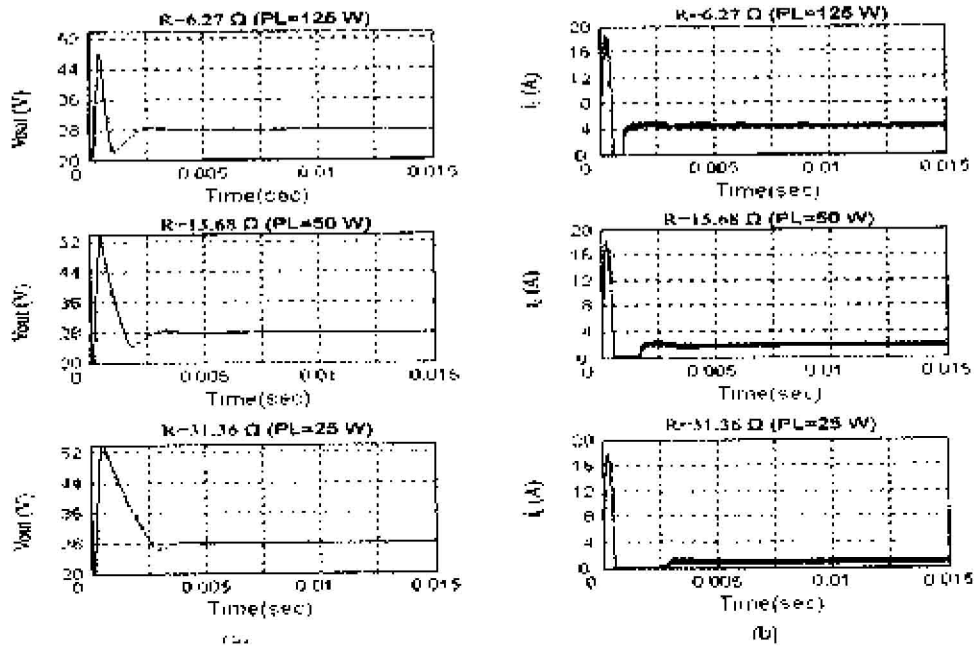

Fig.(10):Simulation results under different loading and an input voltage of 35V

a: Voltage response b: Current response



Fig(12): Simulation results under different loading and no input voltage of 65V

a: Voltage response b: Current response

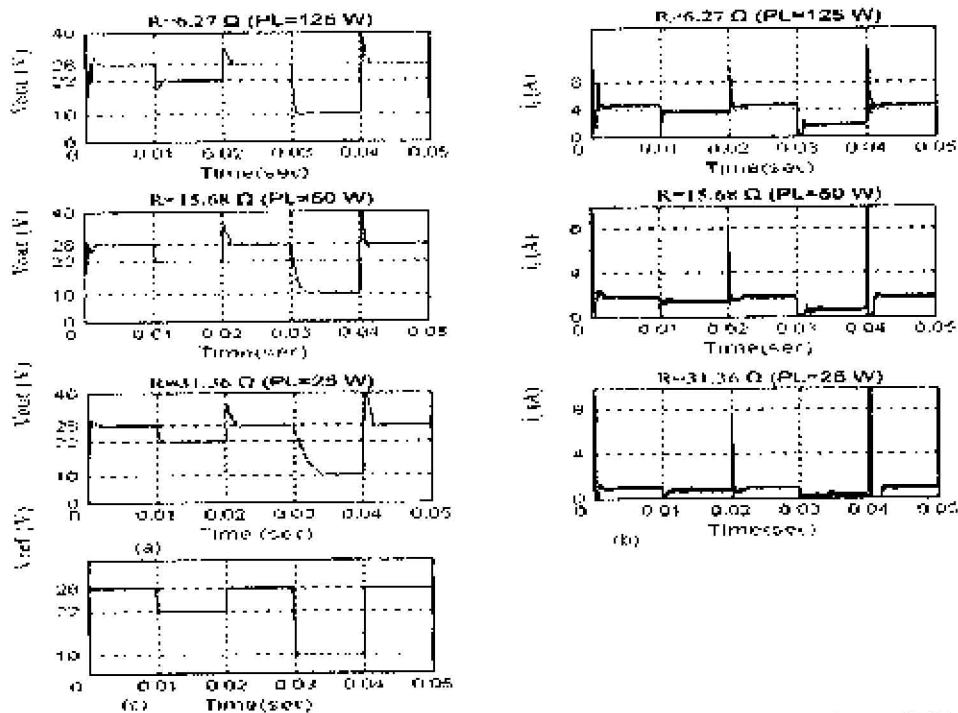

Fig (13): Simulation results under step variation of reference voltage and no input voltage of 35V

a: Voltage response b: Current response c: Reference voltage
a: Voltage response b: Current response

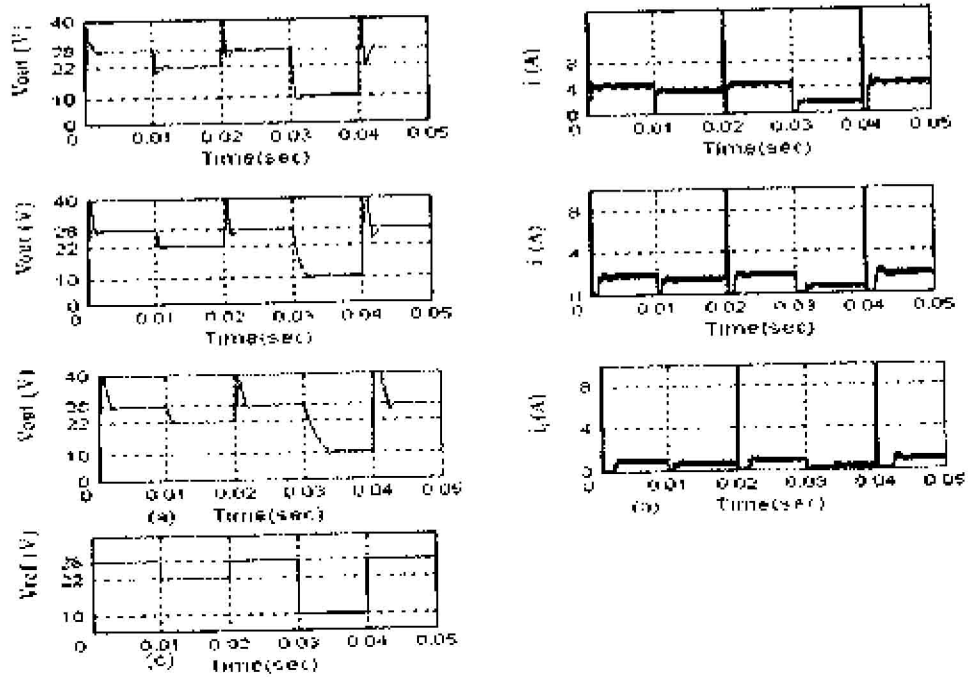

Fig (14): Simulation results under step variation of reference voltage and an input voltage of 50V

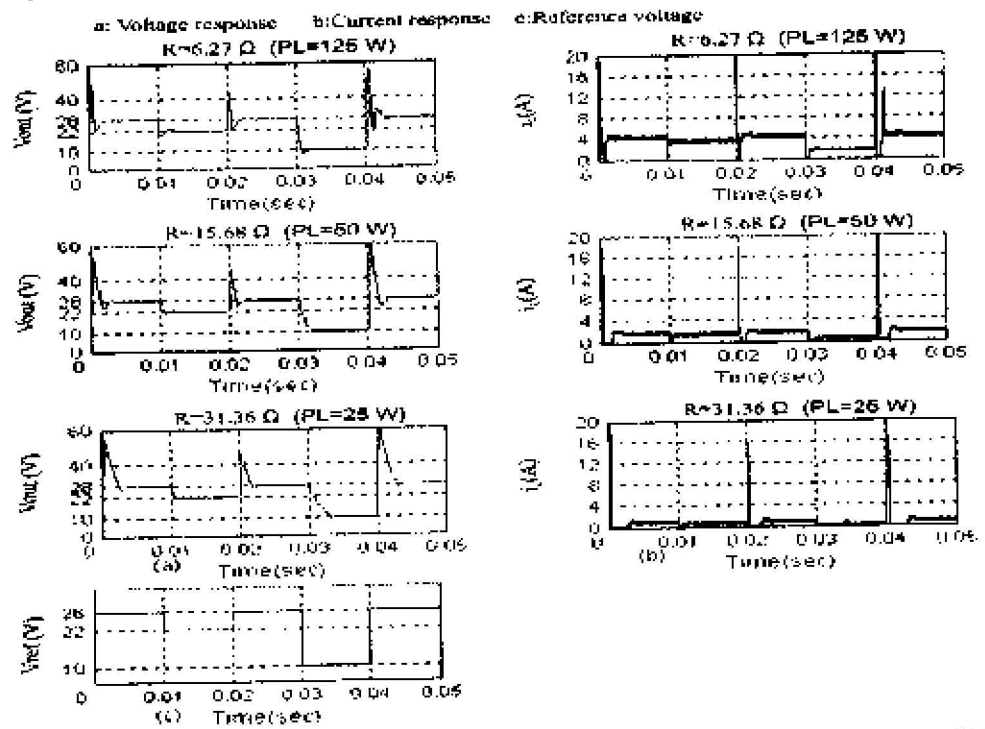

Fig.(15):Simulation results under step variation of reference voltage and an input voltage of 65V

a: Voltage response b: Current response c: Reference voltage

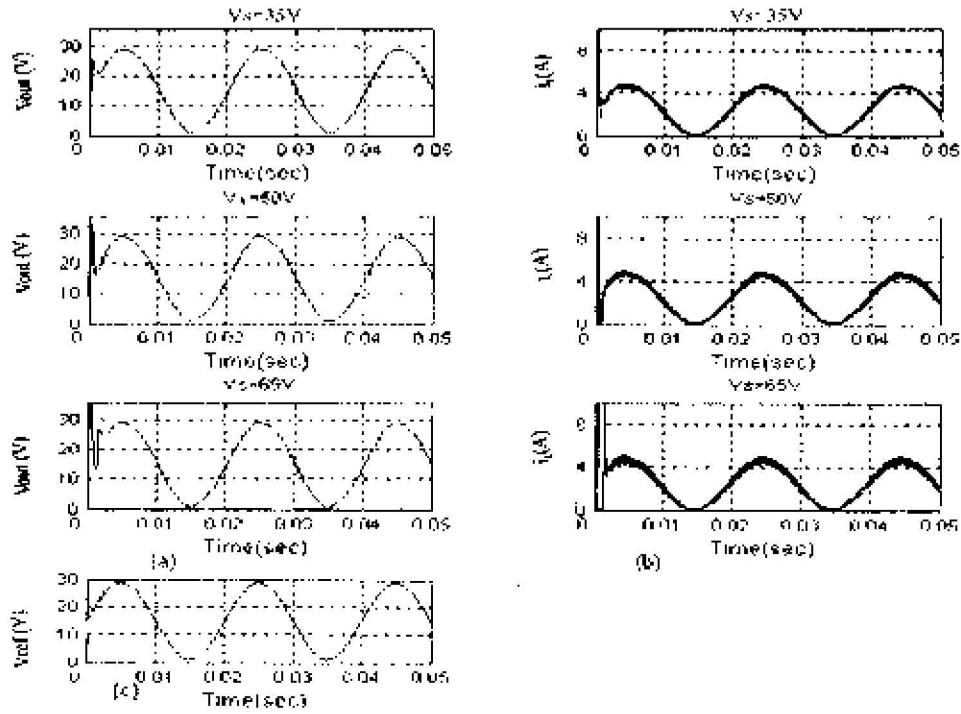

Fig.(18) Simulation results under smooth variation of reference voltage with maximum load resistance
 a: Voltage response b: Current response c: Reference voltage